



Design: Wolfram

T-SKY ecO₂

BEDIENUNGSANLEITUNG TONWERK-SPEICHEROFEN

T-ART ecO₂

INSTRUCTIONS D'UTILISATION DU POELE À ACCUMULATION TONWERK

OPERATING INSTRUCTIONS TONWERK STORAGE HEATING STOVES

ISTRUZIONI PER L'USO DELLA STUFA D'ACCUMULO TONWERK

eco₂ Modul – effizient, komfortabel, sauber



Der T-SKY eco₂ / T-ART eco₂ ist mit einer automatischen, thermostatgesteuerten Zuluftklappe ausgerüstet, die sich nach dem Holzabbrand automatisch verschließt. Ein zu rasches Auskühlen des Speicherofens wird somit verhindert und die Wärmeleistung verlängert.



Der T-SKY eco₂ / T-ART eco₂ ist mit einer selbstschliessenden Feuerraumtüre ausgerüstet, die sich automatisch verriegelt. Gleichzeitig erfüllt die Feuerraumtür die Zulassungskriterien des DIBt für den Einsatz bei raumluftunabhängigem Betrieb (kontrollierte Wohnraumlüftung).



Der Abbrand des Brennholzes im T-SKY eco₂ / T-ART eco₂ erfolgt von oben nach unten. Die Top-Down Verbrennung gewährleistet niedrigste Emissionswerte. Durch den sauberen Abbrand bleibt nur wenig Asche zurück. Mit einer Holzladung erleben Sie ein Flammenspiel von ca. 2 Stunden.



Mit dem Konvektionsmodul des T-SKY eco₂ DUO erhalten Sie im „Handumdrehen“ den Zusatznutzen einer höheren Direktwärmeabgabe in der Anheiz- und Abbrandphase. Wählen Sie bei Bedarf zwischen Konvektionsunterstützung und purer Strahlungswärme.



Als Neuheit besitzen alle T-SKY eco₂ / T-ART eco₂-Modelle einen manuellen Anheizschieber. Die individuell bedienbare Starthilfe zum Anheizen unterstützt bei schwierigen Zug- oder Witterungsbedingungen den Anheizvorgang.

Module eco₂ – efficient, confortable, propre



Le T-SKY eco₂ / T-ART eco₂ est équipé d'une vanne d'air d'amenée commandée par thermostat qui se ferme automatiquement après la combustion du bois. Un refroidissement trop rapide du poêle à accumulation est ainsi empêché et la puissance calorifique est accrue.



Le T-SKY eco₂ / T-ART eco₂ est équipé d'une porte de foyer à fermeture automatique qui se verrouille automatiquement. Cette porte répond en même temps aux critères d'homologation du DIBt pour l'utilisation en fonctionnement indépendant de l'air ambiant (ventilation contrôlée de l'espace d'habitation).



La combustion du bois dans le T-SKY eco₂ / T-ART eco₂ se fait du haut en bas. La combustion du haut en bas garantit les valeurs d'émissions les plus faibles. Grâce à une combustion bien propre, il ne reste que peu de cendre. Avec une charge de bois, le jeu des flammes se poursuit pendant environ 2 heures.



Avec le module de convection du T-SKY eco₂ DUO, vous bénéficiez en un „tour de main“ de l'utilité supplémentaire d'une diffusion directe accrue de chaleur pendant la phase de début de chauffe et de combustion. Au besoin, choisissez entre l'assistance fournie par la convection et la chaleur rayonnante pure.



La nouveauté : tous les modèles T-SKY eco₂ / T-ART eco₂ possèdent une manette d'allumage. Cette aide au démarrage utilisable manuellement facilite l'allumage en cas de mauvais tirage ou de conditions météorologiques difficiles.

eco₂ module – efficient, comfortable, clean



The T-SKY eco₂ / T-ART eco₂ is fitted with an automatic, thermostat controlled air supply flap that closes automatically after the firewood has stopped burning. This prevents the storage heating stove from cooling down too quickly, and heat is emitted longer.



The T-SKY eco₂ / T-ART eco₂ is fitted with a self closing fire chamber door that locks automatically. At the same time the firing chamber door fulfils the DIBt approval criteria for operations independent of indoor air (controlled living space ventilation).



In the T-SKY eco₂ / T-ART eco₂, firewood burns from top to bottom. Topdown combustion has the lowest emissions. This clean mode of combustion leaves only little ash. A single charge of firewood presents flickering flames for about two hours.



The convection module for the T-SKY eco₂ DUO gives you, at the flick of a wrist, the additional benefits of greater direct heat emission in the heating up and burning down phases. Choose whenever you wish between assisted convection or pure radiated heat.



A new innovation for all T-SKY eco₂ / T-ART eco₂ models is the addition of a manual start-up slide. The individually operable starting aid for heating provides support for the heat-up process in the event of difficult wind or weather conditions.

Modulo eco₂: efficiente, comodo e pulito



La T-SKY eco₂ / T-ART eco₂ è dotata di una valvola aria di alimentazione automatica regolata mediante termostato che si chiude automaticamente dopo la combustione del legno. Si impedisce così un raffreddamento troppo rapido della stufa ad accumulo e la potenza calorifica viene prolungata.



La T-SKY eco₂ / T-ART eco₂ è dotata di uno sportello con chiusura autonoma. Contemporaneamente la porta del camino soddisfa i criteri di abilitazione del DIBt per quanto riguarda l'utilizzo in esercizio non in funzione dell'aria (ventilazione controllata degli spazi abitativi).



La combustione della legna da ardere avviene dall'alto al basso nella T-SKY eco₂ / T-ART eco₂. La combustione top-down garantisce minori emissioni. Grazie alla combustione meno inquinante rimangono solo poche ceneri. Con una carica di legna si può avere un bel fuoco per ca. 2 ore.



Con il modulo a convezione della T-SKY eco₂ DUO si hanno «in un batter d'occhio» i vantaggi supplementari di un'emissione di calore diretta maggiore nella fase di accensione e combustione. Se necessario, si può scegliere tra il supporto della convezione e il calore radiante puro.



Come novità tutti i modelli T-SKY eco₂ / T-ART eco₂ dispongono di una valvola di accensione manuale. L'avviamento con comando individuale per l'accensione supporta la procedura in caso di condizioni di tiraggio o climatiche non ottimali.



1.	TONWERK STORAGE HEATING STOVE – A SWISS QUALITY PRODUCT
1.1	The storage heating stove
1.2	The radiated heat
2.	INTERESTING FACTS ABOUT WOOD AND THE ENVIRONMENT
2.1	What is wood?
2.2	Environmental protection
2.3	Buying firewood
2.4	Drying and storing wood
2.5	Wood types and calorific value
2.6	Units of measurement for wood
2.7	What happens when wood burns
3.	APPROVALS AND CERTIFICATIONS
3.1	Approval
3.2	Multiple connection
3.3	CE conformity
3.4	Ratings plate
3.5	Operation independent of indoor air
4.	FIRE PROTECTION
4.1	In-flue draught regulator
4.2	Safety distances to fixed Tonwerk storage heating stoves
4.3	Safety distances to swivelling Tonwerk storage heating stoves
4.4	General safety instructions
4.5	Chimney safety instructions
4.6	Conduct during malfunctions – shutting down safely
5.	OPERATING INSTRUCTIONS
5.1	Before firing the stove for the first time
5.2	About the stove
5.3	General information
5.3.1	Preparations for firing
5.3.2	Instructions for First-time use of the Tonwerk storage stove
5.3.3	Drying the stovepipe paint
5.3.4	Closing the fire chamber door
5.3.5	Vent pipe and ventilating system
5.3.6	Heating in the transition time and in difficult conditions
5.3.7	Closing the firing chamber door / gasket: During controlled living space ventilation / operations independent of indoor air
5.3.8	The pressure in the installation room
6.	FIRING THE STOVE
6.1	GO module – Heating start flap
6.2	DUO Module – greater direct heat emission (optional)
6.3	Adding more wood
7.	CLEANING AND CARING FOR YOUR STOVE
7.1	Manuel ventiation adjusting device
7.2	Operating manuel ventiation adjusting device
7.3	Cleaning the smoke flue
8.	TIPS & TRICKS
8.1	Pointers
9.	WARRANTY
9.1	Warranty terms
9.2	Excluded from the warranty

1. TONWERK STORAGE HEATING STOVE – A SWISS QUALITY PRODUCT

Thank you for buying a Tonwerk storage heating stove – we are sure you will derive as much pleasure from our product as we do.

These instructions contain interesting and informative facts and all you need to know about the subjects of heating, wood, and operating your Tonwerk storage heating stove. Please read these instructions carefully before using your stove for the first time and keep them in a safe place.

WE ARE SATISFIED WITH OUR WORK WHEN YOU HAVE NO MORE QUESTIONS.

In our energy-conscious times we have made it our mission to extract the maximum possible energy from the raw material wood with the minimum possible emissions.

We want to utilise effectively wood, fire, and the heat they generate.

WE HAVE CREATED A LIVING SPACE FOR YOUR WOOD FIRE – THE TONWERK STORAGE HEATING STOVE!

Your Tonwerk storage heating stove never fails to fascinate with its extraordinary design and a heart of the most innovative technology – **handmade in Switzerland!**

1.1 THE STORAGE HEATING STOVE

The storage heating stove is a fireplace made of ceramic or natural stone. The energy or heat generated by burning wood is absorbed by the ceramic storage core. Once the wood has completely burned, this core, as a heat exchanger, radiates the stored energy in the form of heat at a carefully dosed rate, releasing it over its surface for an extended time into the environment.

1.2 THE RADIATED HEAT

The human organism responds to radiated heat with a particularly pleasant feeling. It is physiologically beneficial and soothing.

Since prehistoric times humans have utilised and enjoyed radiated heat. It is transmitted by electromagnetic waves in the infrared range. Radiated heat travels through air without loss and without heating this. Not until it encounters solid bodies like walls, objects, and also people does it generate heat. This effect is familiar to everyone from sunny winter days.

Even when the air is very cold you can feel the warm rays of the sun on your skin.

It makes you feel a temperature that is higher than the actual air temperature. This explains the great benefits and the sustainability of radiated heat.

2. INTERESTING FACTS ABOUT WOOD AND THE ENVIRONMENT

2.1 WHAT IS WOOD?

Do you know what you are putting in the firing chamber of your Tonwerk storage heating stove when you are filling it with wood

This is 50% carbon, 42% oxygen, 6% hydrogen, and 2% mineral substances, nitrogen, oils, resins, tanning agents, and colorants.

... that is wood!

2.2 ENVIRONMENTAL PROTECTION

Burning firewood releases only as much CO₂ as the tree has absorbed from the atmosphere during its growth.

And when the firewood comes from nearby there are no additional CO₂ emissions from transport.

Wood rotting in the forest generates the same amount of CO₂ as the same wood burning.



2.3 BUYING FIREWOOD

Where can I get my firewood?

BUYING READY-TO-BURN FIREWOOD

Regenerated ready-to-burn firewood can be purchased from dealers:

- stove-ready, stored for at least two years
- predried, stored for one year
- fresh from the forest

Every dealer has a wood moisture meter that they use to test the wood they buy. The ideal residual moisture is 12–15% and should be no higher!

TREATING FIREWOOD YOURSELF

Unseasoned wood can be purchased from the forestry office, owners of woodland, or the community:

- trunks lying in the forest
- seasoned trunks by the wayside

Whether you have cut your own wood or bought it, the important thing is: **the wood should be dried for at least two years before it is burned!**

See for further information:
www.hki-online.de/en

2.4 DRYING AND STORING WOOD

DRYING

The water content of firewood has a great effect on its burning properties. Your wood should be as dry as possible. Only then can it give off much heat and burn without polluting the environment. Freshly cut wood can contain between 45 and 60% moisture depending on the season and type. After the optimal drying this water content drops to below 15%. Depending on the wood type this can take about two years, and even longer for some kinds.

STORAGE

If



Damp wood damages your fireplace and reduces efficiency!

Firewood is to dry thoroughly, it must be cut into small pieces.

Check this yourself: the circumference should be max 20–25 cm. Store the wood out of doors, protect it from rain and snow, and make sure it is well ventilated.



What you must not burn: refuse, wet wood, briquettes!

2.5 WOOD TYPES AND CALORIFIC VALUE

The calorific value describes the heat energy released when one kilogram of fuel is burned under specific conditions.

The calorific value is based on the volume specified in stacked or solid cubic metres.

The various wood types have various calorific values:

TREE	CALORIFIC VALUE
Hardwoods	
beech, oak, locust	2100 kWh/stcm
birch	1900 kWh/stcm
sycamore	1900 kWh/stcm
Softwoods	
Douglas fir, pine	1700 kWh/stcm
larch	1700 kWh/stcm
spruce, fir	1500 kWh/stcm

The values are based on 15% residual wood moisture!

A TONWERK STORAGE HEATING STOVE CAN BE FIRED WITH ALL OF THE ABOVE WOOD TYPES.



The many oils and resins in larchwood also provide for an acoustic fireworks!

2.6 UNITS OF MEASUREMENT FOR WOOD

Solid cubic metre (scm): As its name suggests, the solid cubic metre corresponds to one cubic metre of solid as opposed to stacked wood.

Stacked cubic metre (stcm) or stere (st): A stacked cubic metre or stere corresponds to one cubic metre of stacked wood including the gaps between layers. One stere equals 0.7 solid cubic metres.

Loose cubic metre (lcm): The loose cubic metre is a measure for chopped firewood that is loosely packaged for trade and transport. One loose cubic metre is 0.7 steres or about 0.5 solid cubic metres.

NOTE THE SPECIFIED UNIT OF MEASUREMENT WHEN ORDERING!

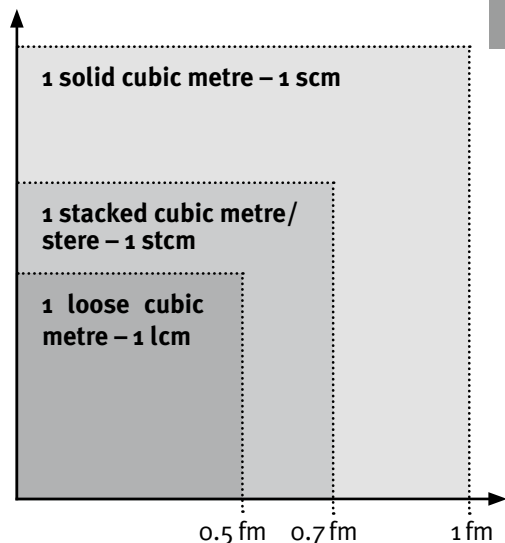

2.7 WHAT HAPPENS WHEN WOOD BURNS

Burning or combustion is a rapid oxidation of substances forming flames. When wood burns, the oxygen in the air combines with the carbon and hydrogen in the wood. In the process, energy is released in the form of heat and light. In the ideal case the products of complete combustion are only carbon dioxide, ashes (formed primarily of the wood's mineral constituents), and water.

The combustion process on firewood can be divided roughly into three phases.

Heating and drying – In this first phase the water and other volatile substances stored in the firewood evaporate.

Pyrolysis – In this second phase the firewood decomposes at temperatures from about 150 °C.

Actual combustion – In this third phase the gases formed in the first two phases react with additional oxygen from the atmosphere to form carbon dioxide and water. Also any remaining charcoal burns completely with time in the combustion zone. Only ashes remain as the single residue of combustion. Each phase of combustion can be observed very easily on an open fire.



Burning wood is a proactive contribution to climate protection!



A fire needs three things: fuel, oxygen, and heat.

3. APPROVALS AND CERTIFICATIONS

3.1 APPROVAL

Standard for slow heat release appliances fired by solid fuel: DIN EN 15250 operation independent of indoor air
DIBt **Z-43.12-383**

3.2 MULTIPLE CONNECTION SELF-CLOSING FIRING CHAMBER DOOR

The Tonwerk storage heating stove is fitted as standard with a self closing firing chamber door. This is an important operating and safety element. The door closes automatically as soon as it is released. Consequently the Tonwerk storage heating stove is suitable for connection to flues with multiple installations (several stoves connected to the same flue).

3.4 CE CONFORMITY

The manufacturer, Tonwerk Lausen AG, confirms that the Tonwerk storage heating stove conforms to the standards under EN 15250 and that the quality requirements are constantly monitored.

3.6 OPERATION INDEPENDENT OF INDOOR AIR

Operating your stove independently of indoor air requires a direct external supply of air to the air nozzle in the base of the stove. The connectors must be airtight. Your Tonwerk storage heating stove is designed for operation at an air/gas flue or with a separate combustion air line (FC61X). Check regularly that the firing chamber door closes properly and the air and gas ways are tight.

Room sealed appliances and multiple connection of the flue

For air independent operation with domestic ventilation is a multiple connection of the flue only allowed inside the same living unit.

3.5 RATINGS PLATE

The type plate is found on the left inner side of the housing.

4. FIRE PROTECTION

The national and European standards, the local and building legislation, and the fire safety terms and conditions must be observed without condition.

Your chimney sweep or Tonwerk partner company will be pleased to inform you.

4.1 IN-FLUE DRAUGHT REGULATOR

It is advisable to install a draught regulator to guarantee a constant flue draught.

4.2 SAFETY DISTANCES TO FIXED TONWERK STORAGE HEATING STOVES: T-SKY eco_2 / T-ART eco_2

Safety distance A

The side and rear panels must be no closer than 10 cm to flammable materials

Safety distance B

Smoke pipes must be no closer than 20 cm to flammable materials

Safety distance C + D

Flammable floor materials must be no closer than 50 cm to the front and 30 cm to the sides

Safety distance E

Firing chamber apertures must be no closer than 80 cm to flammable materials within the radiation zone

Safety distance F

The minimum distance from the ceiling is: T-SKY eco_2 = 25 cm
T-ART eco_2 = 50 cm

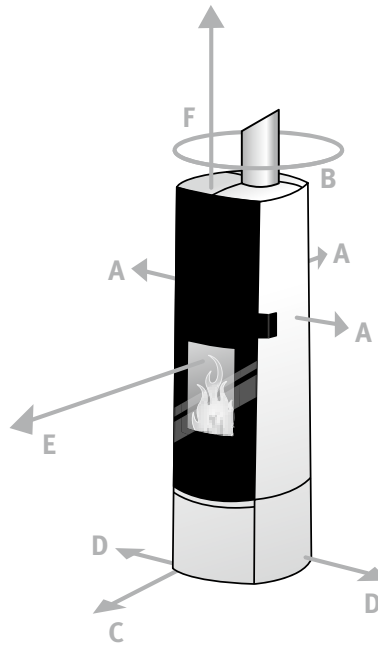

4.3 SAFETY DISTANCES TO SWIVELLING TONWERK STORAGE HEATING STOVES: T-SKY eco_2 / T-ART eco_2

Safety distance A

The side and rear panels must be no closer than 10 cm to flammable materials

Safety distance B

Smoke pipes must be no closer than 20 cm to flammable materials

Safety distance C+D

The distance over the whole swivelling angle must be no less than 50 cm

Safety distance E

A minimum distance of 80 cm applies to the whole swivelling range

Safety distance F

The minimum distance from the ceiling is: T-SKY eco_2 = 25 cm
T-ART eco_2 = 50 cm

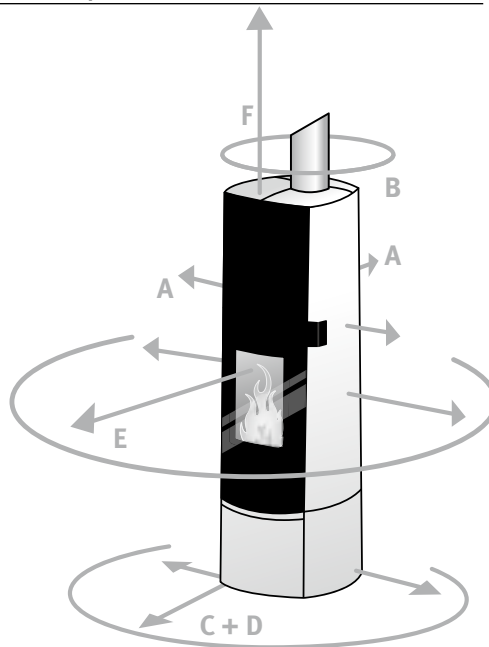

In front of the oven, apply protection in the form of a non-combustible covering.

Suitable items for this purpose include base plates made of stone, ceramic, sheeting or securit glass.

4.4 GENERAL SAFETY INSTRUCTIONS

- Never leave children alone or unattended at a burning fire place.
- Teach your children how to behave properly and operate safely the fire place.
- Every stove gets hot when fired: risk of burning!
- Avoid touching the outside surfaces when the stove is operating.
- Do not burn refuse or painted wood.
- Dispose of the ashes only after they have cooled completely.
- Inform your specialised dealer without delay of defect gaskets.
- Observe the information in our operating instructions and make a proactive contribution to fire prevention and the protection of our environment.

4.5 CHIMNEY SAFETY INSTRUCTIONS

The required chimney flue shall be 12 Pa. If the height and cross-section of the chimney cannot be adapted to meet the requirements, this may result in wind-related problems and consequently disrupted combustion, as well as formation of condensation. If the chimney flue is too high, draught stabilisers shall be installed. Local and national regulations must be complied with. If the chimney catches fire, immediately call the fire brigade.

4.6 CONDUCT DURING MALFUNCTIONS – SHUTTING DOWN SAFELY

In rare cases, also a pilot fire can fail to generate a draught in the flue

You must then ask your chimney sweep for advice. On no account must you attempt to light a larger fire. When smoke escapes from your stove, air the room immediately and contact your chimney sweep. You should then refrain from firing your stove.

5. OPERATING INSTRUCTIONS

5.1 BEFORE FIRING THE STOVE FOR THE FIRST TIME

Dear Customer, You have now been instructed by one of our specialised dealers on how to fire your Tonwerk storage heating stove.

In these operating instructions we wish to set down each step that you must take if you are to encounter no problems when operating your Tonwerk storage heating stove.

Read through these operating instructions carefully and keep them in a safe place. Your specialised dealer will be pleased to assist you with any questions you may have.

5.3 GENERAL INFORMATION

5.3.1 PREPARATIONS FOR FIRING

Have ready an adequate supply of chopped firewood, ecofriendly lighting aids, and kindling. You are best storing the wood in a warm room for a number of days before firing

5.3.2 INSTRUCTIONS FOR FIRST-TIME USE OF THE TONWERK STORAGE STOVE

1. Heat your stove for the first time with around $\frac{3}{4}$ of the quantity of wood specified in the operating instructions (around 4 kg), without piling it up.
2. Repeat the above process a 2nd time, after a minimum of around 8 – 10 hours have elapsed, and then after another 8 hours have elapsed, operate it with a full load of wood, or pile up as desired.

5.3.3 DRYING THE STOVEPIPE PAINT

After you have heated the oven in accordance with 5.3.2, add some more firewood for the stovepipe paint to dry out completely.

5.2 ABOUT THE STOVE

What's what?

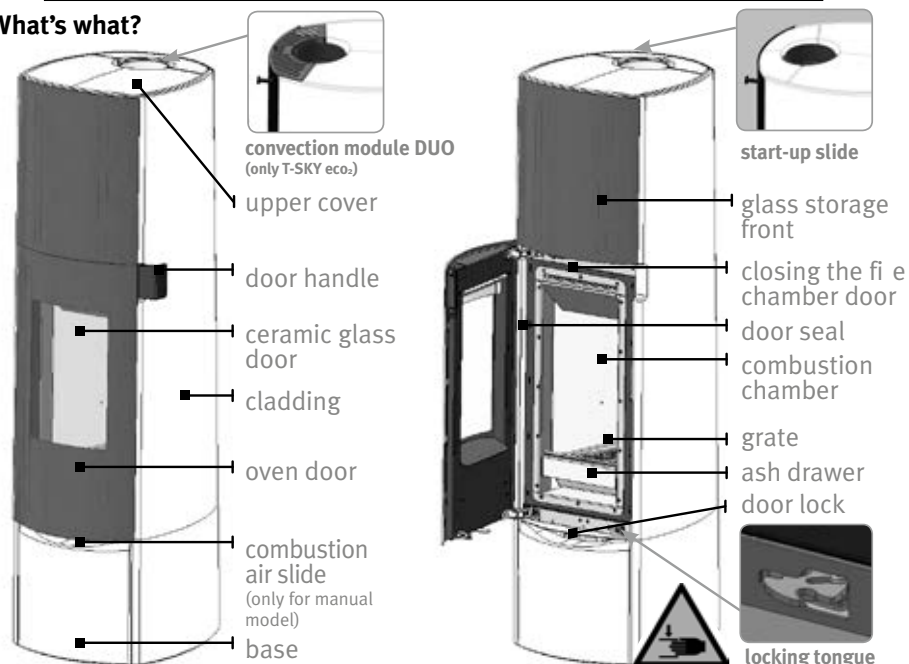

5.3.4 CLOSING THE FIRE CHAMBER DOOR

The optimal closing of the fire chamber door allows for convenient filling and maintenance of the fire chamber.

If your stove is used in a house/flat with an incoming and outgoing ventilation system, the door must be able to close automatically at any time.

In this case, using the door lock is at the user's own risk.

Operation: Make sure not to press against the closed door in order to prevent damages to the mechanics.

5.3.5 VENT PIPE AND VENTILATING SYSTEM

Operation with indoor air: Extractor hoods and ventilating systems can affect the operation of your Tonwerk storage heating stove. Please make sure that there is adequate incoming air for multiple installations. Operating the extractor hood and ventilating system can force dangerous flue gases out of the stove and into the room. Under the firing regulations, joint operations are permitted only in conjunction with a flue gas controller. When the extractor hood or ventilating system is put into operation, at least one window in the room must be open.

Operation independent of indoor air: Make sure that the room is adequately ventilated when your stove is operating independently of indoor air. When the firing chamber door is opened for more firewood, there must be no sustained underpressure in the room.

5.3.6 HEATING IN THE TRANSITION TIME AND IN DIFFICULT CONDITIONS

In damp or foggy weather, at outdoor temperatures from 15 °C, and during the transition time you are advised to light a pilot fire before firing the stove proper. This serves to displace the cold, heavy air in the chimney and to create the right conditions for the optimal extraction of smoke.

This pilot fire is lit with paper in the chimney's inspection aperture until extraction is assured.

5.3.7 CLOSING THE FIRING CHAMBER DOOR / GASKET: DURING CONTROLLED LIVING SPACE VENTILATION / OPERATIONS INDEPENDENT OF INDOOR AIR

Always make sure that the firing chamber door closes properly and that the door gasket is undamaged and intact!



A defect door gasket can cause flue gas to leak into the living space and jeopardise health.

5.3.8 THE PRESSURE IN THE INSTALLATION ROOM

The supplier of the ventilation system must ensure that the pressure does not exceed 4 Pa.



The pressure in the installation room may not exceed 4 Pa.

6. FIRING THE STOVE



Manual model T-SKY eco₂ / T-ART eco₂

Open the firebox door. Open the combustion air slide, by moving the control lever all the way to the right to the “Symbol +”. Open the heating start flap when initial heating is difficult, by pulling the control knob backwards.

Automatic model T-SKY eco₂ / T-ART eco₂

Open the heating start flap when initial heating is difficult, by pulling the control knob backwards.

Now place around 6 wooden logs (around 33cm long, each around 0.8 kg in weight) into the firebox. The firing chamber is slightly inclined to the rear, to ensure the wooden logs remain at the back, against the rear wall of the firing chamber and do not topple over against the pane of glass. If the wooden logs are cut at an angle and resting against the firebox door, you must turn the logs until they are inclined to the rear. **Place pairs of wooden logs behind each other, as compactly as possible** ensure that free space of around 2cm is allowed between the wood and the side wall of the firebox. The front ash collar must not be covered with wood.

Insert 1-2 fire lighters (impregnated starter cubes) in the middle of the standing wooden logs and cover them with a generous quantity of small kindling. Now light the fire lighters and release the firebox door.

The firebox door will automatically close and establish a seal.

Close the heating start flap when flames emerge, to ensure optimal through-ventilation for the storage core. For this purpose, push the control knob into the original position as far as it will go.

Once the wooden logs have burnt down, insert another 2 logs, each around 0.8 kg. Depending on the degree of compactness and flue draught, the fully-loaded quantity of 6 kg will burn down in 120 to 150 minutes.

CAUTION!

Avoid opening the firebox door at any time during the combustion and burnout phases.

NOTE!

If the firebox door does not close properly (e.g. due to “warping” of the lock when cleaning), the storage stove must not be operated. In this case, try to bring the lock latch into the starting position or inform the specialist dealer.

Manual model

When the wood has burnt completely and all the flames have disappeared, switch the combustion air slide to the “Symbol -“ which shuts off the air supply.

Automatic model

When the wood has burnt completely and all that is left is residual embers in the firebox, the automatic air flap closes on its own.

6.1. GO MODULE – HEATING START FLAP



GO Module closed



GO Module open

The T-SKY eco₂ models all include a manual start-up slide.

The individually operable starting aid provides support for the heat-up process in the event of difficult wind or weather conditions. Open the heating start flap by moving the control knob backwards as far as it will go. To close, push the control knob to the front as far as it will go.

6.2. DUO MODULE – GREATER DIRECT HEAT EMISSION (OPTIONAL ONLY T-SKY eco₂)

When you wish greater direct heat emission during the heating up and burning down phases, simply open the convection module all or part of the way after igniting the charge. To open, push the lever (A) to the front to the stop. When you wish to raise the proportion of radiated heat, close the Duo Module all or part of the way by pushing the lever back to its initial position. When you want to utilise direct heat emission while you are emptying

the storage heating stove, simply leave the convection module open. Bear in mind that direct heat emission reduces the heat storage capacity and causes your storage heating stove to cool down faster.

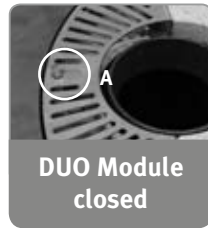

DUO Module closed

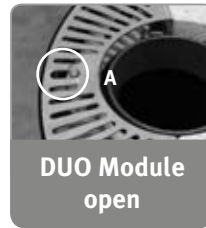

DUO Module open



The flow of hot air heats the convection module. Please use the glove when operating the stove.

6.3 ADDING MORE WOOD



When you want to heat for longer, add two pieces of firewood when there is an adequate basic firebed. When building the fire or adding wood, distribute any remaining coals evenly with a poker.

Slowly open the firing chamber door, first a gap, so that the pressure in the firing chamber is equalised. This helps to prevent ash from flying into the room. Distribute the basic firebed evenly over the firing chamber base, place one-off two pieces of firewood against the rear wall of the combustion chamber, and release the firing chamber door. The new firewood ignites in a few minutes and burns from bottom to top.

No firewood may be added when the basic firebed is higher than the ash shield.



Manual model T-SKY eco₂ / T-ART eco₂:

When the wood has burnt up completely and all the flames have disappeared, switch the combustion air slide to the "Symbol –", which shuts off the air supply.

Automatic model:

When the wood has burnt up completely, the thermostatically-controlled air-inlet flap closes automatically, which helps ensure lasting emission of the radiant heat.

NOTE!

Opening the firing chamber door always and automatically opens the air supply flap. This closes again when the firewood has burned completely and there are only embers in the firing chamber.



You must ensure that a window in the room is open in the event of operation with ambient air.

7. CLEANING AND CARING FOR YOUR STOVE

Empty the ash drawer as soon as it is full. Only empty when the stove is cold into a fireproof container (embers - fire hazard). If necessary you can clean the window with a moist cloth and some ashes. Repeat for stubborn soiling or use a special flue window cleaner. When using a fireplace glass cleaner, please make sure no liquid enters the space between the window and the door chassis. The liquid can damage the printing on the window.

Opening the firing room door for cleaning purposes also opens the air supply flue. We recommend cleaning the stove before it is fired again.

Rough surfaces on the outer cladding can be vacuumed off with an upholstery attachment. Polished surfaces are cleaned with a spraywet cloth. The provided cleaning stone is used to remove stub-born soiling. Under no circumstances must you use hard brushes or chemical cleaning agents. The optimal functionality can be assured only when the chimney, stovepipe, and stove are cleaned at least once a year.

7.1 MANUEL VENTILATION ADJUSTING DEVICE

When you do not intend to fire the stove for a long time after cleaning or opening the firing chamber door (e.g. during the summer months), please press the manuel ventiliation adjusting device to close the air supply valve.



Under no circumstances may the manuel ventiliation adjusting device be pressed to stop the supply of air prematurely to burning firewood!

7.2 OPERATING MANUEL VENTILATION ADJUSTING DEVICE

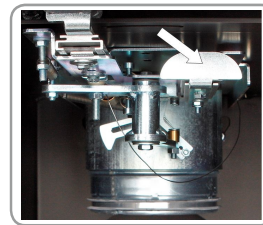

The manuel ventiliation adjusting device can only activated by closing firing chamber door

Use a 10 cm long screwdriver or similar, to operate the manuel ventiliation adjusting device between the glass panel and the base.

7.3 CLEANING THE FLUE GAS PASS

Remove the stone covers **1**, loosen the screws on the cleaning cover and the flus gas cover **2** and remove this, then pull out the flue gas di enter **3**.

Now clean the stove pipe and the smoke flue with a suitable sweeper and remove the residues with a vacuum cleaner. Now put the items back into their starting positions and screw the cleaning cover and the flue gas cover back down again. Check the function of the heating start flap **4**; the slider should be sliding smoothly.

top outlet:

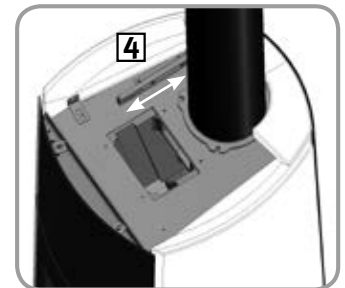
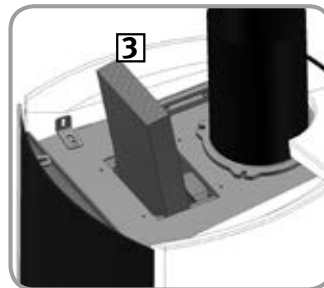
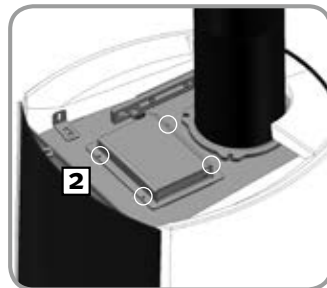
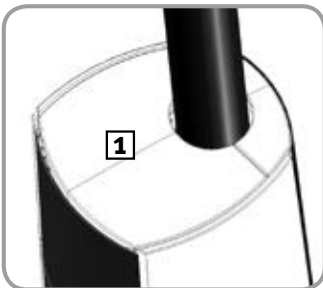

rear outlet:

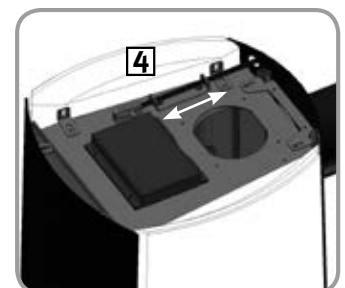
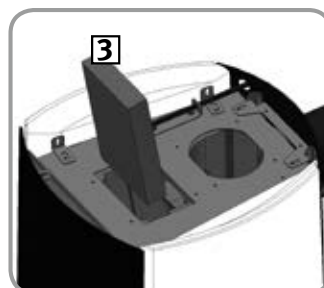
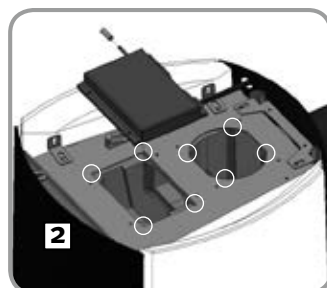
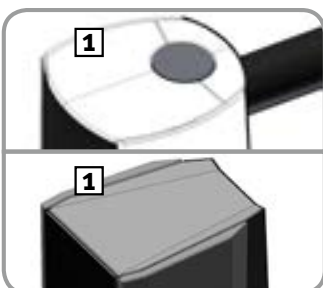

8. TIPS & TRICKS

Wood does not ignite when stove is fired; fire just smoulders away; fire extinguishes:

- kindling unsuitable
- wood too damp
- firewood too thick

Heavy sooting in the firing chamber; heavy sooting on the window:

- open the combustion air supply
- too little wood
- firewood damp or too thick

Smoke escapes from the stove:

- assure adequate extraction in the chimney, light pilot fire
- provide for adequate supply of air

8.1 POINTERS

When operating the T-SKY with balanced flue operation, it is advisable after each period of heating to have the state of the door seal checked by a professional and replaced as required.

The firebox is made of vermiculite and high-quality firebricks. All types of refractory material are subject to thermal stresses, which may lead to cracks. For this reason, any crack in the lining of the firebox is a sign of natural wear and tear.

Your specialised dealer will be pleased to assist you with any further questions you may have.

9. WARRANTY

We grant a five year warranty for your new Tonwerk storage heating stove. The warranty period begins on the day the stove is installed and tested by the specialised dealer. Warranty claims become valid when the purchase price for the stove has been paid in accordance with the agreement and the warranty certificate has been completed and returned within thirty days to Tonwerk Lausen AG. If one of these conditions is not fulfilled the minimum warranty of six months applies.

9.1 WARRANTY TERMS

- proper installation by a specialised dealer
- the storage heating stoves are handled in accordance with these operating instructions and the safety instructions marked by this symbol:

- no continuous firing
- no overheating
- Regular (once a year) maintenance by a specialist.
- There must be no modifications to the stove structure: these can cause malfunctions and permanent damage
- Only genuine original parts should be used

9.2 EXCLUDED FROM THE WARRANTY

- wearing parts like gaskets, cast grate, fireclay, and glass
- smoke and soot damage
- natural discoloration or deviating colours on the outer cladding
- cracks in the refractory material (fireclay) have no effect on the safe functioning of the Tomwerk storage heating stove
- damage incurred through failure to observe these operating instructions
- damage covered by an insurance policy or other agreement

WE WISH YOU MANY PLEASANT HOURS WITH YOUR TONWERK STORAGE HEATING STOVE.

GARANTIEZERTIFIKAT

Wir gewähren für Ihren neuen Tonwerk-Speicherofen eine Garantie von 5 Jahren. Die Garantielaufzeit beginnt mit dem Tag der Inbetriebnahme durch den Fachhändler. **Der Garantieanspruch tritt dann in Kraft, wenn der Kaufpreis für den Ofen vertragsgemäß entrichtet ist und das Garantiezertifikat vollständig ausgefüllt innerhalb 30 Tagen an die Tonwerk Lausen AG zurückgesendet wird.**

Wird eine dieser Bedingungen nicht erfüllt, so gilt die Mindestgarantie von 6 Monaten.

CERTIFICAT DE GARANTIE

Nous vous apportons une garantie de 5 ans pour votre poêle à accumulation neuf. La période de garantie commence à courir à partir de la date de mise en service par le distributeur spécialisé.

Votre prétention à la garantie entre en vigueur au moment où vous vous êtes acquitté du prix d'achat du poêle fixé par contrat, et si vous avez renvoyé dans un délai de 30 jours à la Tonwerk Lausen AG le certificat de garantie intégralement rempli.

Si l'une de ces conditions n'est pas respectée, on appliquera une garantie minimale de 6 mois.

WARRANTY CERTIFICATE

We grant a five year warranty for your new Tonwerk storage heating stove. The warranty period begins on the day the stove is installed and tested by the specialised dealer.

Warranty claims become valid when the purchase price for the stove has been paid in accordance with the agreement and the warranty certificate has been completed and returned within thirty days to Tonwerk Lausen AG.

If one of these conditions is not fulfilled the minimum warranty of six months applies.

CERTIFICATO DI GARANZIA

Per la vostra nuova stufa d'accumulo Tonwerk vi offriamo una garanzia di 5 anni. Il periodo di garanzia ha inizio il giorno della messa in funzione da parte del rivenditore specializzato.

Il diritto alla garanzia entra in vigore quando il prezzo d'acquisto della stufa è pagato conformemente al contratto e il certificato di garanzia è rispedito compilato in tutte le sue parti entro 30 giorni a Tonwerk Lausen AG.

Tonwerk Lausen s.p.a., verrà applicata la garanzia minima di 6 mesi.



info@tonwerk-ag.com

www.tonwerk-ag.com

Tiba AG

Hauptstrasse 147

CH-4416 Bubendorf

Telefon: +41 (0) 61 935 17 10

Fax: +41 (0) 61 931 11 61

TONWERK 

 **SPEICHERÖFEN**
MADE IN SWITZERLAND